

# R-TEC AUTOMATION® TRACK SINGLE SPLICE ASSEMBLY INSTRUCTIONS

**!STOP!** Scan this QR code and please watch the video.  
Please read all instructions carefully before starting.



## INTRODUCTION:

R-TEC Automation® Track Systems are used to electronically control the drapery using a Slim Drapery Motor and Remote Control. By using a Remote Control or the R-TEC Automation® App via a smartphone or tablet, the operator can open and close the drapery smoothly and precisely.

The maximum track width for this system is 36' spliced. The minimum width for this system is 37". The max. drapery weight is 110 lbs. There must be two additional brackets - one for each side of the splice when used.

## SPLICE ASSEMBLY:

**Step 1.** Carefully unbox your system, leaving all the packaging materials in place. If a second person is available to help, it will make the re-assemble process faster and easier.

**NOTE:** The system was packaged with foam, shrink wrap and other packing materials to ensure the belt, carriers and other components stay in place during shipment.

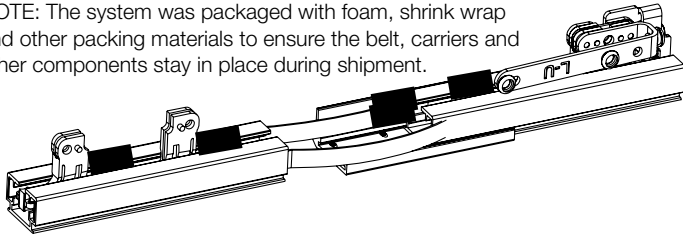

**Step 2.** Remove all packaging material from the Track, ensuring the Drive Belt stays in place inside the Track.

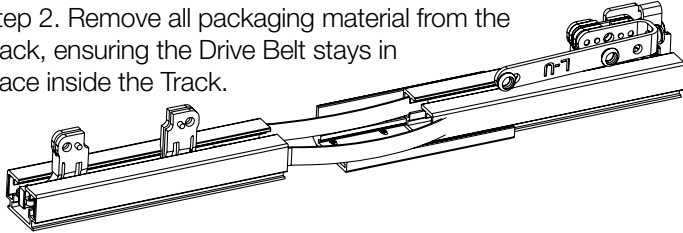

**Step 3.** Bring the Track sections together by pushing the Track onto the Splice and moving the Master Carrier forward.

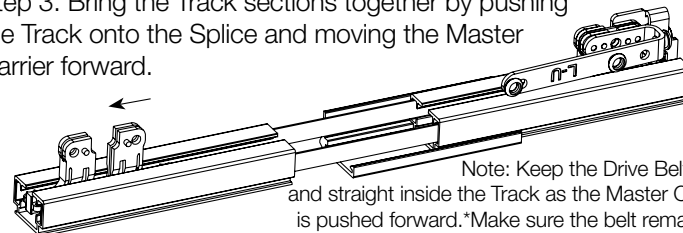

Note: Keep the Drive Belt tight and straight inside the Track as the Master Carrier is pushed forward.\*Make sure the belt remains in the track channels and is not pinched as the splice sections move forward.

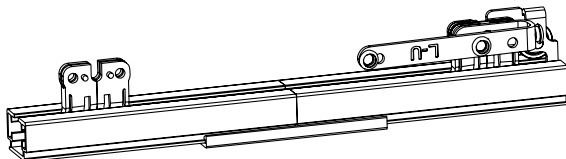

**Step 4.** Bring both Master Carrier Body halves together and insert the center clip.

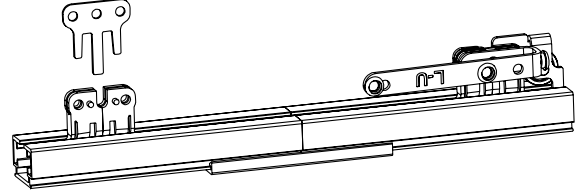

**Step 5.** Tighten the Splice set screws.

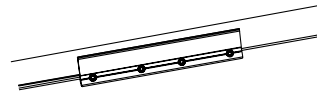

**Step 6.** To complete your system, assemble the Master Carrier Arm. Then move the master carrier the full length of track 2 to 4 times to ensure the system components are correctly installed before mounting the system on the wall.

**RIPPLEFOLD:** Wrap the cord around the Master Carrier Body and fasten the Arm to the Master Carrier Body.

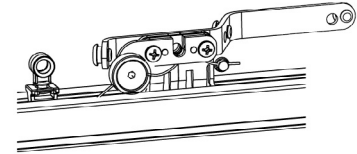
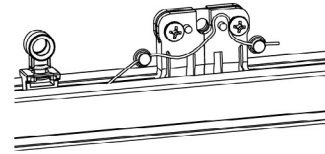

**NOTE:** To remove or add pinch pleat carriers, watch this video:



**NOTE:** To remove or add Ripplefold carriers, watch this video:

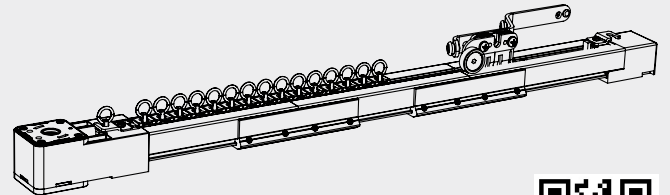

**Step 7.** Your system is ready to be installed using these installation instructions:



**BRACKET ASSEMBLY:**

The R-TEC Track can be mounted on the wall or ceiling.

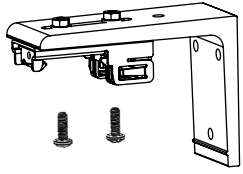

Wall Mount Assembly

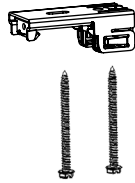

Ceiling Mount Assembly

NOTE: The installer is responsible for selecting the correct fastener for attaching the ceiling mount clip to the ceiling.

**PARTS LIST:**

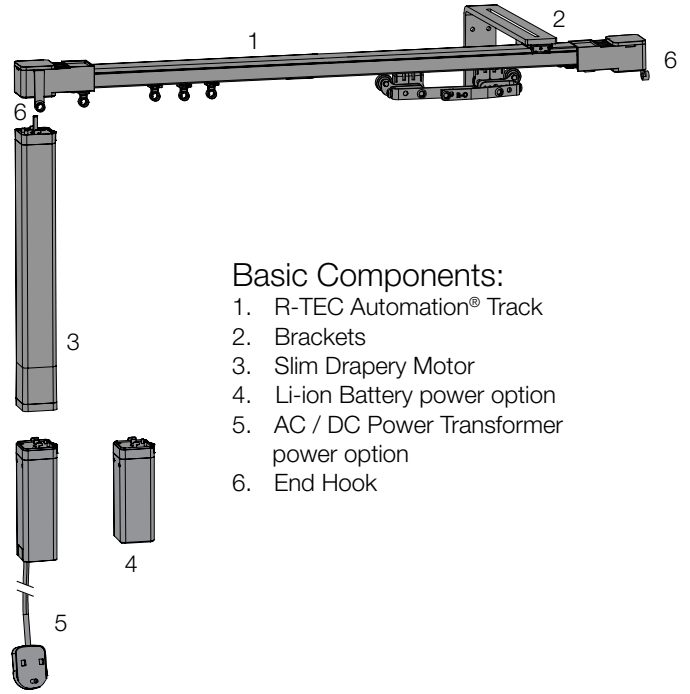

**Basic Components:**

1. R-TEC Automation® Track
2. Brackets
3. Slim Drapery Motor
4. Li-ion Battery power option
5. AC / DC Power Transformer power option
6. End Hook

**BRACKET PLACEMENT:**

It's recommended to use 1 bracket beside each pulley. On the remaining part of the R-TEC Automation® Track, bracket-to-bracket distances should be no more than 24". Also, 1 bracket should be placed on each side of a splice if used.

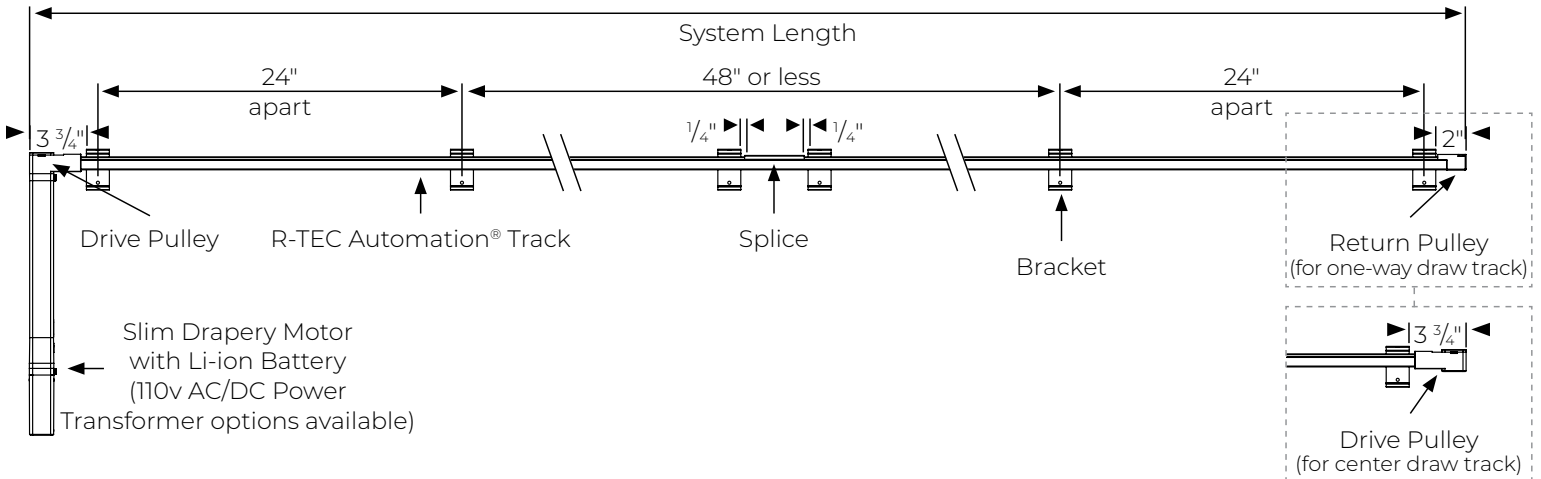

**INSTALLATION:**

We recommend using a professional installer. Installation hardware is included. The fasteners (screws and anchors) may not be appropriate for every installation or wall material. Brackets and holdbacks should be installed securely into wall studs when possible. Rowley will not assume responsibility for damages incurred by improperly mounted or inadequately supported hardware.