

FINESTRA® WOOD R-TEC AUTOMATION® TRAVERSE SINGLE SPLICE ASSEMBLY INSTRUCTIONS

!STOP! Scan this QR code and please watch the video.
Please read all instructions carefully before starting.



INTRODUCTION:

Finestra® Wood R-TEC Automation® Traverse Systems are used to electronically control the drapery using a Slim Drapery Motor and Remote Control. By using a Remote Control or the R-TEC Automation® App via a smartphone or tablet, the operator can open and close the drapery smoothly and precisely.

The maximum fascia and track width for this system is 36' spliced. The max. drapery weight is 110 lbs. There must be two additional brackets - one for each side of the splice when used.

SPLICE ASSEMBLY:

Step 1. Carefully unbox your system, leaving all the packaging materials in place. If a second person is available to help, it will make the re-assemble process faster and easier.

NOTE: The system was packaged with foam, shrink wrap and other packing materials to ensure the belt, carriers and other components stay in place during shipment.

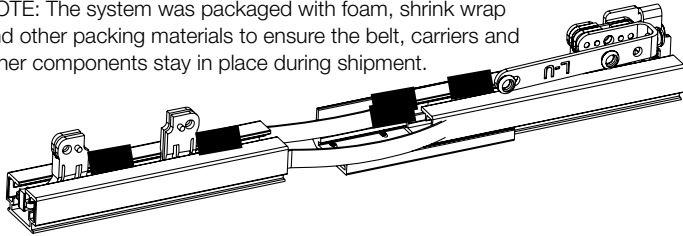

Step 2. Remove all packaging material from the Track, ensuring the Drive Belt stays in place inside the Track.

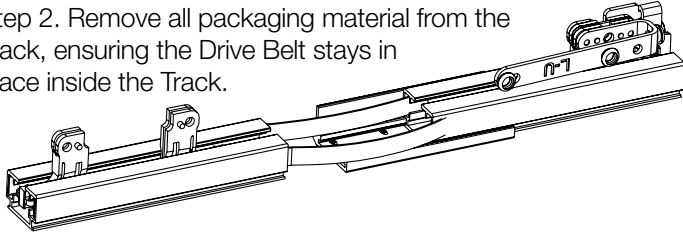

Step 3. Bring the Track sections together by pushing the Track onto the Splice and moving the Master Carrier forward.

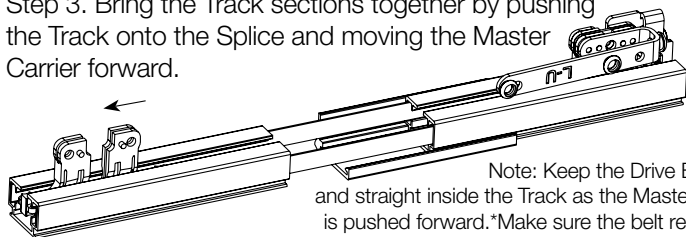

Note: Keep the Drive Belt tight and straight inside the Track as the Master Carrier is pushed forward.*Make sure the belt remains in the track channels and is not pinched as the splice sections move forward.

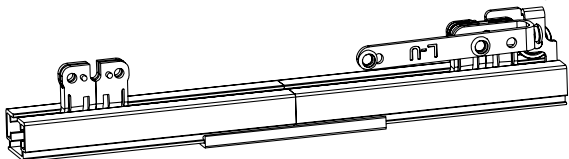

Step 4. Bring both Master Carrier Body halves together and insert the center clip.

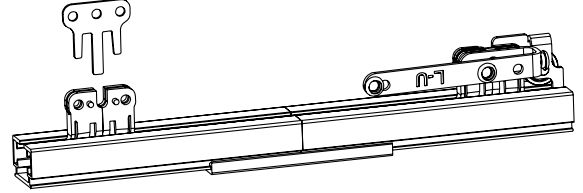

Step 5. Tighten the Splice set screws.

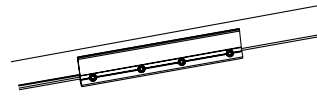

Step 6. To complete your system, assemble the Master Carrier Arm. Then move the master carrier the full length of track 2 to 4 times to ensure the system components are correctly installed before mounting the system on the wall.

RIPPLEFOLD: Wrap the cord around the Master Carrier Body and fasten the Arm to the Master Carrier Body.

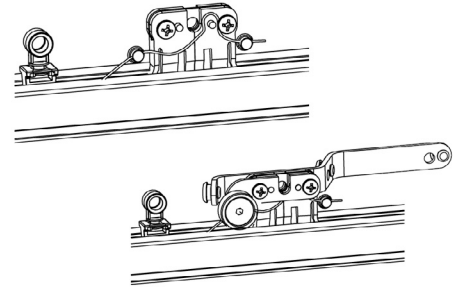

NOTE: To remove or add pinch pleat carriers, watch this video:



NOTE: To remove or add Ripplefold carriers, watch this video:

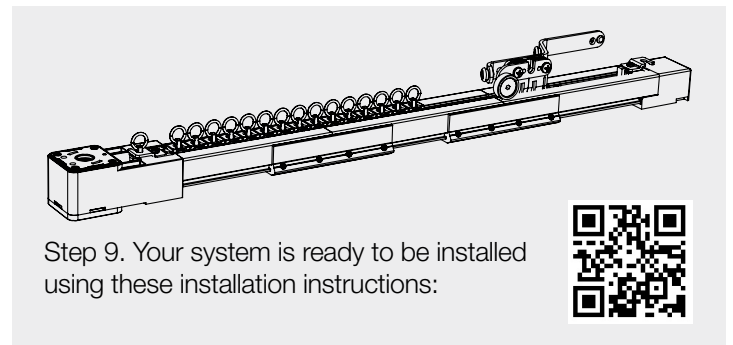

Step 9. Your system is ready to be installed using these installation instructions:

