



# WOOD HARDWARE

## 2024 PRICE GUIDE

[FINESTRAWOODHARDWARE.COM](http://FINESTRAWOODHARDWARE.COM)



SMART HOME  
COLLECTION

by BUDGET BLINDS®

# AUTOMATED TRAVERSE

September 2024

Finestra® Quick Ship orders will ship the same day if ordered by 3 PM EST.

Please allow a 5 day lead time on manual traverse system orders and a 10 - 15 day lead time on Smart Home motorized traverse system orders.





## WOOD HARDWARE

The Finestra® Wood Hardware collection offers the perfect combination of classic finial designs in 1 3/8" and 2" diameters and furniture-quality finishes that coordinate seamlessly with decorative elements throughout the home.

- **Smart Home Assemble To Order Decorative Drapery Hardware Traverse Systems**
- Traverse systems available in 1 3/8" and 2" wood fascia diameter options and a wide array of traversing solutions
- Pair the beauty of Finestra Wood finials with the superior functionality of our Smart Home Assemble To Order Decorative Drapery Hardware Traverse Systems



## CONTENTS

Automated Traverse Systems	pages 3 - 5
Manual Traverse Systems	pages 6 - 11
1 3/8" Finials, Poles, Brackets & Rings	pages 12 - 14
2" Finials, Poles, Brackets & Rings	pages 14 - 16
Holdbacks	page 16
Order Forms	pages 17 - 19

## SALES TOOLS

WHOLESALE COST



Finish Sample Ring FSWFS/1.....\$10.00



Wall Unit FSW3000/W.....\$200.00



Automated Traverse Retro Wall Unit Display CSRTMFSW3000/W..\$150.00



Portable Display Kit FSWPDK/1.....\$99.00



# SMART HOME COLLECTION

by BUDGET BLINDS®

## SMART HOME JUST GOT SMARTER

Smart Home Assemble To Order  
Decorative Drapery Hardware  
Traverse Systems

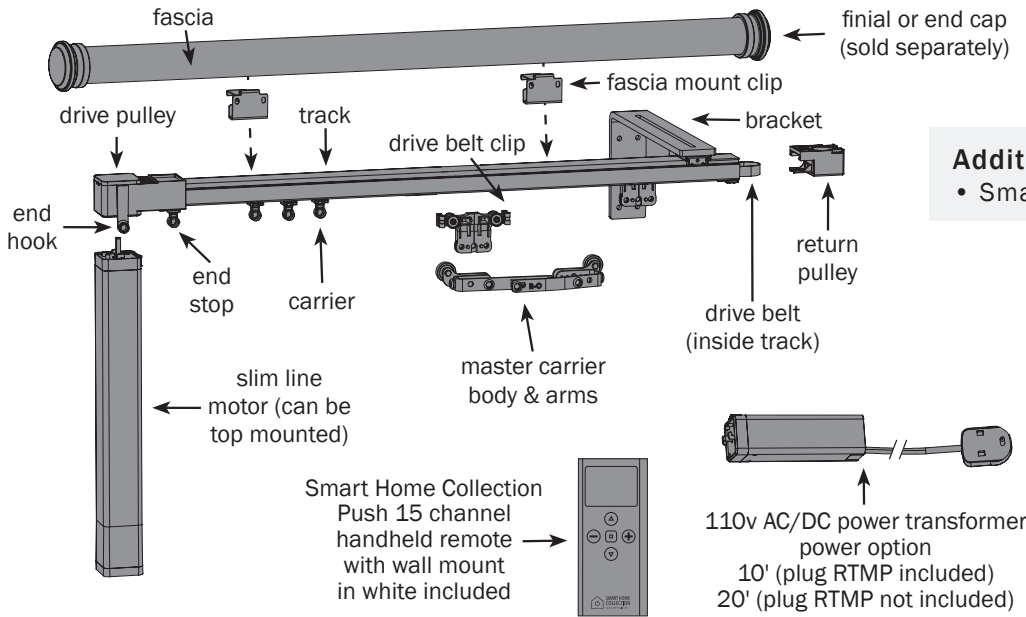

**Additional Options:**  
• Smart Home Controls | page 5

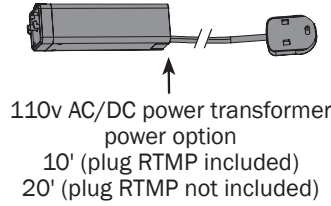
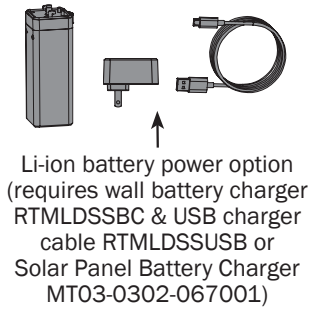

## CONNECTED HOME

We've partnered with Rollease Acmeda, a leader in smart home technology, to offer unparalleled convenience in controlling your draperies, all at the touch of a button.

## IT'S AS EASY AS

Our Smart Home Collection Decorative Drapery Hardware Traverse Systems available through Finestra® Wood Hardware are easy to install, easy to afford and use the latest integrated wireless technology. You can use the included Smart Home Collection Push15 remote, app, Alexa or Google Home to control your draperies and window coverings. Motorization helps keep your draperies safe by eliminating cords and allows you to experience a new level of privacy when integrating Smart Home Collection drapery and window covering solutions.

## SMART HOME DISPLAY KIT



	WHOLESALE COST
Case & Kit to showcase the Smart Home Collection. Order modules and Smart Home Controls sold separately.	RTMDK.....\$300.00
Smart Home Track Module with 1 3/8" Fascia	RTMDK/TRACK.....\$100.00
Slim Line Drapery Motor + Battery Kit	RTMLDKIT.....\$371.00
Smart Home Shade Module (includes motor + battery)	RTMDK/SHADE.....\$100.00

## TANDEM ALTERNATIVE

Tandem alternative ARC™ motorized systems utilize two drapery motors and are used for draperies that exceed the maximum single motor capacity. Available with Butt Master One-Way Draw Arms RTMDTOB (recommended for Ripplefold draperies), Butt Master Center Draw Arms RTMDTCDB (Ripplefold only) or Overlap Tandem Center Draw Arms RTMDTCDTAN (recommended for pinch pleat draperies). Please contact Rowley for details.

# QUICK SHIP FINISHES

Espresso.....ES	Pecan.....PE
Mahogany.....MA	Antique White.....AW
Walnut.....WA	Unfinished (Stationary systems only).....UF

\*Quick Ship orders will ship the same day if ordered by 3 PM EST. Please allow a 5 day lead time on manual traverse system orders and a 10 - 15 day lead time on automated traverse system orders.









# CUSTOM SHIMMER FINISHES

For a minimal 25% surcharge, we will add a light shimmer of gold or silver to accentuate your Finestra Wood Hardware Finish.

Espresso/Gold Shimmer.....ES/GS	Espresso/Silver Shimmer.....ES/SS
Mahogany/Gold Shimmer.....MA/GS	Mahogany/Silver Shimmer.....MA/SS
Walnut/Gold Shimmer.....WA/GS	Walnut/Silver Shimmer.....WA/SS
Pecan/Gold Shimmer.....PE/GS	Pecan/Silver Shimmer.....PE/SS
Antique White/Gold Shimmer.....AW/GS	Antique White/Silver Shimmer.....AW/SS

\*Please allow a 5 day lead time on all custom shimmer finishes.

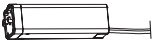
# MOTOR & MOTOR ACCESSORIES

	Description	Item #	Color	UOM	Suggested Retail Price (SRP)
	 Slim Line Motor	RTMLDSS50	White	EA	\$494.67
	 Li-ion Battery (requires Wall Battery Charger & USB Charger Cable)	RTMLDSSB	White	EA	\$296.80
<b>Li-ion Battery Powered</b>	 Wall Battery Charger, 5V, 2A	RTMLDSSBC	White	EA	\$37.10
	 USB Charger Cable, 13', 20 AWG	RTMLDSSUSB	White	EA	\$37.10
	 <b>ECO friendly</b> Gen 2 Solar Panel Battery Charger: includes L-Bracket, Cables & Fastener	MT03-0302-067002	Black and Aluminum	EA	\$170.00
	 Slim Line Motor	RTMLDSS50	White	EA	\$494.67
<b>110v AC/DC Powered</b>	 110v AC/DC Power Transformer 10' (plug RTMP included)	RTMDSSPT	White	EA	\$173.13
	 110v AC/DC Power Transformer 20' (plug RTMP not included)	RTMDSSPTCS	White	EA	\$185.50
	 3 Conductor Male Plug	RTMP	White	EA	\$61.83

# AUTOMATED TRAVERSE SYSTEMS



10 - 15 day lead time. Continuous Fascia Length: 4' - 12'. Spliced Length: up to 36'. All traverse orders will incur a \$33.35 packaging fee per order.

	Description	Item #	Diameter	Length	Finishes	UOM	SINGLE	DOUBLE
 <p><b>Automated Ripplefold or Pinch Pleat</b>            * Includes fascia, architectural track(s), slim line motor(s), power module option(s), pulleys, brackets, master carriers, carriers, end hooks, end stops, drive belt &amp; clips and a Smart Home Collection Push 15 channel handheld remote with wall mount. See below for additional control options and pricing. Does not include finials.</p> <p><b>Use the order form on page 17</b>            For double systems, add DBL to the item #</p>	Smooth, Reeded	CSSHCFWSW138	1 3/8"	4'	ES, MA, WA, PE, AW	EA	\$1,721.44	\$3,313.60
	Smooth, Reeded	For Double Systems, add DBL to the item #	1 3/8"	6'	ES, MA, WA, PE, AW	EA	\$1,820.38	\$3,511.46
	Smooth, Reeded	Price / add'l ft	1 3/8"	8'	ES, MA, WA, PE, AW	EA	\$1,919.32	\$3,709.32
	Smooth, Reeded	up to 36' (spliced): Single: \$49.47 Double: \$98.93	1 3/8"	10'	ES, MA, WA, PE, AW	EA	\$2,018.26	\$3,907.18
	Smooth, Reeded		1 3/8"	12'	ES, MA, WA, PE, AW	EA	\$2,117.20	\$4,105.04
	Smooth, Reeded	CSSHCFWSW200	2"	4'	ES, MA, WA, PE, AW	EA	\$1,782.94	\$3,378.57
	Smooth, Reeded	For Double Systems, add DBL to the item #	2"	6'	ES, MA, WA, PE, AW	EA	\$1,931.34	\$3,675.37
	Smooth, Reeded	Price / add'l ft	2"	8'	ES, MA, WA, PE, AW	EA	\$2,079.74	\$3,972.17
	Smooth, Reeded	up to 36' (spliced): Single: \$74.20 Double: \$148.40	2"	10'	ES, MA, WA, PE, AW	EA	\$2,228.14	\$4,268.97
	Smooth, Reeded		2"	12'	ES, MA, WA, PE, AW	EA	\$2,376.54	\$4,565.77

## SMART HOME CONTROLS

- The Hub and Smart Home Collection Budget Blinds App integration allow draperies to be controlled directly from a smartphone or integrated device while at home or away. Available in the Apple® App Store or Google Play™, just search Smart Home Collection Budget Blinds, and select the Smart Home Collection Budget Blinds App.
- As an alternative, remotes and wall switches allow for individual, group and all control for a customized solution with 1, 2, 5 or 15 channel options.

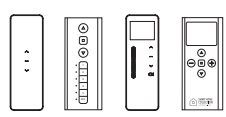
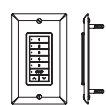
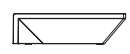

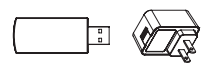
	Description	Item #	Description	UOM	SRP	
 <p>Handheld Remotes with Wall Mounts</p>	1 Channel	MTRF-REM-1C	White, Range: 65'	EA	\$116.67	
	15 Channel, Level Control	MTRF-REM-15NL	White, Range: 65'	EA	\$140.00	
	Push 5 Channel	MT02-0101-067016	White, Range: 65'	EA	\$116.67	
	Push 5 Channel	MT02-0101-050016	Black, Range: 65'	EA	\$116.67	
	Smart Home Collection Push 15 Ch	MT02-0101-067017	White, Range: 65', included in all systems	EA	\$140.00	
	Smart Home Collection Push 15 Ch	MT02-0101-050017	Black, Range: 65'	EA	\$140.00	
	Surface Mount Wall Switch 5 Channel	MTRF-WS5-FLUSH	White, Range: 65'	EA	\$150.00	
	Smart Home Collection Wi-Fi Hub with HomeKit; 2-way RF	MT02-0401-067004	White, Range: 60'	EA	\$330.00	
	Interior Sun Sensor	MTRF-SUNSENS	White, Range: 65'	EA	\$100.00	
	ARC USB Signal Repeater *Color may vary.	Repeater Wall Charger	MT02-0401-069007 MT03-0301-069008	Extends the wireless range of the Smart Home Collection Hub and Remotes up to 60' Maximum 2 repeaters per system or network	EA EA	\$183.33 \$20.00

# BATON DRAW - MANUAL TRAVERSE SYSTEMS - RIPPLEFOLD

5 day lead time. Continuous Fascia Length: 4' - 12'. Spliced Length: up to 36'. All traverse orders will incur a \$33.35 packaging fee per order.

Description	Item #	Diameter	Length	Finishes	UOM	SINGLE	DOUBLE
Smooth, Reeded	CSFSWT1384003N/	1 3/8"	4'	ES, MA, WA, PE, AW	EA	\$314.11	\$502.09
Smooth, Reeded	For double systems, add /D to the item #	1 3/8"	6'	ES, MA, WA, PE, AW	EA	\$452.61	\$719.75
Smooth, Reeded	Price / add'l ft up to 36' (spliced): Single: \$69.25 Double: \$108.83	1 3/8"	8'	ES, MA, WA, PE, AW	EA	\$591.11	\$937.41
Smooth, Reeded		1 3/8"	10'	ES, MA, WA, PE, AW	EA	\$729.61	\$1,155.07
Smooth, Reeded		1 3/8"	12'	ES, MA, WA, PE, AW	EA	\$868.11	\$1,372.73
Smooth, Reeded	CSFSWT2004003N/	2"	4'	ES, MA, WA, PE, AW	EA	\$375.95	\$563.92
Smooth, Reeded	For double systems, add /D to the item #	2"	6'	ES, MA, WA, PE, AW	EA	\$539.19	\$811.26
Smooth, Reeded	Price / add'l ft up to 36' (spliced): Single: \$81.62 Double: \$123.67	2"	8'	ES, MA, WA, PE, AW	EA	\$702.43	\$1,058.60
Smooth, Reeded		2"	10'	ES, MA, WA, PE, AW	EA	\$865.67	\$1,305.94
Smooth, Reeded		2"	12'	ES, MA, WA, PE, AW	EA	\$1,028.91	\$1,553.28

## Baton Draw Ripplefold No Rings

\* Includes fascia, track, brackets, master carriers, carriers and track end caps. Does not include finials or batons.

### Use the order form on page 18

For double systems, add /D to the item #

# BATON DRAW - MANUAL TRAVERSE SYSTEMS - PINCH PLEAT

5 day lead time. Continuous Fascia Length: 4' - 12'. Spliced Length: up to 36'. All traverse orders will incur a \$33.35 packaging fee per order.

Description	Item #	Diameter	Length	Finishes	UOM	SINGLE	DOUBLE
Smooth, Reeded	CSFSWT1384003N/	1 3/8"	4'	ES, MA, WA, PE, AW	EA	\$314.11	\$502.09
Smooth, Reeded	For double systems, add /D to the item #	1 3/8"	6'	ES, MA, WA, PE, AW	EA	\$452.61	\$719.75
Smooth, Reeded	Price / add'l ft up to 36' (spliced): Single: \$69.25 Double: \$108.83	1 3/8"	8'	ES, MA, WA, PE, AW	EA	\$591.11	\$937.41
Smooth, Reeded		1 3/8"	10'	ES, MA, WA, PE, AW	EA	\$729.61	\$1,155.07
Smooth, Reeded		1 3/8"	12'	ES, MA, WA, PE, AW	EA	\$868.11	\$1,372.73
Smooth, Reeded	CSFSWT2004003N/	2"	4'	ES, MA, WA, PE, AW	EA	\$375.95	\$563.92
Smooth, Reeded	For double systems, add /D to the item #	2"	6'	ES, MA, WA, PE, AW	EA	\$539.19	\$811.26
Smooth, Reeded	Price / add'l ft up to 36' (spliced): Single: \$81.62 Double: \$123.67	2"	8'	ES, MA, WA, PE, AW	EA	\$702.43	\$1,058.60
Smooth, Reeded		2"	10'	ES, MA, WA, PE, AW	EA	\$865.67	\$1,305.94
Smooth, Reeded		2"	12'	ES, MA, WA, PE, AW	EA	\$1,028.91	\$1,553.28

## Baton Draw Pinch Pleat No Rings

\* Includes fascia, track, brackets, master carriers, carriers and track end caps. Does not include finials or batons.

### Use the order form on page 18

For double systems, add /D to the item #

# DECORATIVE BATONS

\*Fiberglass batons in coordinating Finestra Wood Hardware quick ship finishes.

	Description	Item #	Finishes	UOM	Suggested Retail Price (SRP)
 Steel - S	36" Baton with Plastic Attachment	FSW312A/	ES, MA, WA, PE, AW*	EA	\$33.67
	36" Baton with Steel Clip	FSW312S/	ES, MA, WA, PE, AW*	EA	\$33.67
	48" Baton with Plastic Attachment	FSW314A/	ES, MA, WA, PE, AW*	EA	\$38.34
	48" Baton with Steel Clip	FSW314S/	ES, MA, WA, PE, AW*	EA	\$38.34
	60" Baton with Plastic Attachment	FSW316A/	ES, MA, WA, PE, AW*	EA	\$44.52
	60" Baton with Steel Clip	FSW316S/	ES, MA, WA, PE, AW*	EA	\$44.52
 Plastic - A	48" Handicap Baton with Plastic Attachment	BA79A	Clear	EA	\$27.21
	48" Handicap Baton with Steel Clip	BA79S	Clear	EA	\$33.94
	60" Handicap Baton with Plastic Attachment	BA78A	Clear	EA	\$32.78
	60" Handicap Baton with Steel Clip	BA78S	Clear	EA	\$39.57
	72" Handicap Baton with Plastic Attachment	BA77A	Clear	EA	\$30.29
	72" Handicap Baton with Steel Clip	BA77S	Clear	EA	\$37.10
	48" Handicap Baton with Plastic Attachment	BA90A	Fiberglass, White	EA	\$20.41
	60" Handicap Baton with Plastic Attachment	BA91A	Fiberglass, White	EA	\$22.26
	72" Handicap Baton with Plastic Attachment	BA92A	Fiberglass, White	EA	\$24.12

# CORD DRAW - MANUAL TRAVERSE SYSTEMS - RIPPLEFOLD

5 day lead time. Continuous Fascia Length: 4' - 12'. Spliced Length: up to 36'. All traverse orders will incur a \$33.35 packaging fee per order.

Description	Item #	Diameter	Length	Finishes	UOM	SINGLE	DOUBLE
Smooth, Reeded	CSFSWT1384001/	1 3/8"	4'	ES, MA, WA, PE, AW	EA	\$314.11	\$502.09
Smooth, Reeded	For double systems, add /D to the item #	1 3/8"	6'	ES, MA, WA, PE, AW	EA	\$452.61	\$719.75
Smooth, Reeded	Price / add'l ft	1 3/8"	8'	ES, MA, WA, PE, AW	EA	\$591.11	\$937.41
Smooth, Reeded	up to 36' (spliced): Single: \$69.25	1 3/8"	10'	ES, MA, WA, PE, AW	EA	\$729.61	\$1,155.07
Smooth, Reeded	Double: \$108.83	1 3/8"	12'	ES, MA, WA, PE, AW	EA	\$868.11	\$1,372.73
Smooth, Reeded	CSFSWT2004001/	2"	4'	ES, MA, WA, PE, AW	EA	\$375.95	\$563.92
Smooth, Reeded	For double systems, add /D to the item #	2"	6'	ES, MA, WA, PE, AW	EA	\$539.19	\$811.26
Smooth, Reeded	Price / add'l ft	2"	8'	ES, MA, WA, PE, AW	EA	\$702.43	\$1,058.60
Smooth, Reeded	up to 36' (spliced): Single: \$81.62	2"	10'	ES, MA, WA, PE, AW	EA	\$865.67	\$1,305.94
Smooth, Reeded	Double: \$123.67	2"	12'	ES, MA, WA, PE, AW	EA	\$1,028.91	\$1,553.28



## Cord Draw Ripplefold No Rings

\* Includes fascia, track, brackets, master carriers, carriers, cord, tension device and end pulleys. Does not include finials.

### Use the order form on page 19

For double systems, add /D to the item #

# CORD DRAW - MANUAL TRAVERSE SYSTEMS - PINCH PLEAT

5 day lead time. Continuous Fascia Length: 4' - 12'. Spliced Length: up to 36'. All traverse orders will incur a \$33.35 packaging fee per order.

Description	Item #	Diameter	Length	Finishes	UOM	SINGLE	DOUBLE
Smooth, Reeded	CSFSWT1384001/	1 3/8"	4'	ES, MA, WA, PE, AW	EA	\$314.11	\$502.09
Smooth, Reeded	For double systems, add /D to the item #	1 3/8"	6'	ES, MA, WA, PE, AW	EA	\$452.61	\$719.75
Smooth, Reeded	Price / add'l ft	1 3/8"	8'	ES, MA, WA, PE, AW	EA	\$591.11	\$937.41
Smooth, Reeded	up to 36' (spliced): Single: \$69.25	1 3/8"	10'	ES, MA, WA, PE, AW	EA	\$729.61	\$1,155.07
Smooth, Reeded	Double: \$108.83	1 3/8"	12'	ES, MA, WA, PE, AW	EA	\$868.11	\$1,372.73
Smooth, Reeded	CSFSWT2004001/	2"	4'	ES, MA, WA, PE, AW	EA	\$375.95	\$563.92
Smooth, Reeded	For double systems, add /D to the item #	2"	6'	ES, MA, WA, PE, AW	EA	\$539.19	\$811.26
Smooth, Reeded	Price / add'l ft	2"	8'	ES, MA, WA, PE, AW	EA	\$702.43	\$1,058.60
Smooth, Reeded	up to 36' (spliced): Single: \$81.62	2"	10'	ES, MA, WA, PE, AW	EA	\$865.67	\$1,305.94
Smooth, Reeded	Double: \$123.67	2"	12'	ES, MA, WA, PE, AW	EA	\$1,028.91	\$1,553.28



## Cord Draw Pinch Pleat No Rings

\* Includes fascia, track, brackets, master carriers, carriers, cord, tension device and end pulleys. Does not include finials.

### Use the order form on page 19

For double systems, add /D to the item #



# TRAVERSE FASCIAS

















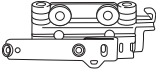

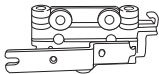







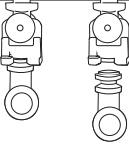

Can be custom cut for a \$5 cut fee FinestraCC. Please allow a 2 day lead time on all custom cut orders. All orders with a fascia will incur a \$33.35 packaging fee per order.

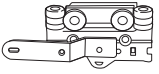
Description	Item #	Diameter	Length	Finishes	UOM	Suggested Retail Price (SRP)
6' Smooth Fascia	FSWT138S06/	1 3/8"	6'	ES, MA, WA, PE, AW	EA	\$86.94
	FSWT200S06/	2"	6'	ES, MA, WA, PE, AW	EA	\$182.68
8' Smooth Fascia	FSWT138S08/	1 3/8"	8'	ES, MA, WA, PE, AW	EA	\$116.92
	FSWT200S08/	2"	8'	ES, MA, WA, PE, AW	EA	\$245.40
12' Smooth Fascia	FSWT138S12/	1 3/8"	12'	ES, MA, WA, PE, AW	EA	\$160.95
	FSWT200S12/	2"	12'	ES, MA, WA, PE, AW	EA	\$347.32
6' Reeded Fascia	FSWT138F06/	1 3/8"	6'	ES, MA, WA, PE, AW	EA	\$86.94
	FSWT200F06/	2"	6'	ES, MA, WA, PE, AW	EA	\$182.68
8' Reeded Fascia	FSWT138F08/	1 3/8"	8'	ES, MA, WA, PE, AW	EA	\$116.92
	FSWT200F08/	2"	8'	ES, MA, WA, PE, AW	EA	\$245.40
12' Reeded Fascia	FSWT138F12/	1 3/8"	12'	ES, MA, WA, PE, AW	EA	\$160.95
	FSWT200F12/	2"	12'	ES, MA, WA, PE, AW	EA	\$347.32

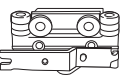



























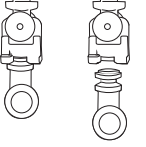

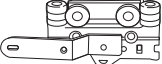

# BATON DRAW - TRAVERSE COMPONENTS

\*Components are white. Look for the  icon for components available in bronze and add /BR at the end of the item number to order.

	Style	Item #	Description	UOM	Suggested Retail Price (SRP)
	Wall Bracket	BT5433 	2 1/2" to 3 1/2" Projection	EA	\$6.54
	Heavy Duty Double Wall Bracket	BT5444 	Front Projection 5" - 6 1/4", Rear Projection 2 1/4" - 3 1/2"	EA	\$39.75
	Fascia Mount Clip	FSWT4003N	Fascia Mount Clip for 4003N Track	EA	\$4.42
	Finial Mount Adaptor	FSWT400	Finial Mount Adaptor for Wood Fascia	EA	\$4.42
	Ripplefold Master Carriers - Hidden Baton	BT3125L 	For hidden baton. 6 wheels. Left.	EA	\$19.96
		BT3125R 	For hidden baton. 6 wheels. Right.	EA	\$19.96
	Ripplefold Master Carriers - Exposed Baton	BT3123L 	For exposed baton. 6 wheels. Left.	EA	\$19.96
		BT3123R 	For exposed baton. 6 wheels. Right.	EA	\$19.96
	Ripplefold Butt Master Carriers	BT3600L 	Allows fold to butt together at the center of a center draw, creating no overlap. 3 snaps securely affix fabric to Butt Master.	EA	\$20.67
		BT3600R 		EA	\$20.67
	End Cap for Ripplefold	BT4123 	End Cap with roller Ripplefold Carrier	EA	\$4.95
	Ripplefold Friction Carrier, partial roll with 166 carriers	R1120/P	1 7/8" Spacing, 120% Fullness	ROLL	\$218.54
		R1100/P	2 1/8" Spacing, 100% Fullness	ROLL	\$218.54
		R1080/P	2 3/8" Spacing, 80% Fullness	ROLL	\$218.54
		R1060/P	2 5/8" Spacing, 60% Fullness	ROLL	\$218.54
	Ripplefold Roller Carrier, detachable pendant, partial roll with 166 carriers	R2120/P 	1 7/8" Spacing, 120% Fullness	ROLL	\$371.00
		R2100/P 	2 1/8" Spacing, 100% Fullness	ROLL	\$371.00
		R2080/P 	2 3/8" Spacing, 80% Fullness	ROLL	\$371.00
		R2060/P 	2 5/8" Spacing, 60% Fullness	ROLL	\$371.00
	Pinch Pleat Master Carriers - Hidden Baton	BT3005L 	For hidden baton. 8 wheels. Left.	EA	\$16.78
		BT3005R 	For hidden baton. 8 wheels. Right.	EA	\$16.78
	Pinch Pleat Master Carriers - Exposed Baton	BT3003L 	For exposed baton. 8 wheels. Left.	EA	\$16.78
		BT3003R 	For exposed baton. 8 wheels. Right.	EA	\$16.78
	End Cap for Pinch Pleat	BT4013 	End Cap with Carrier for drapery pin	EA	\$4.59
	Micro Ball Bearing Carrier	CP10 	3 drapery pin holes, 5/8" width top	10/PK	\$10.42

# CORD DRAW - TRAVERSE COMPONENTS

\*Components are white. Look for the  icon for components available in bronze and add /BR at the end of the item number to order.



	Style	Item #	Description	UOM	Suggested Retail Price (SRP)	
	Wall Bracket	CD543 	3 1/4" Projection	EA	\$16.78	
	Double Wall Bracket	CD544 	Front Projection 5 1/2" - 7", Rear Projection 2 1/2" - 4 1/2"	EA	\$39.75	
	Fascia Mount Clip	FSWT4001	Fascia Mount Clip for 4001 Track	EA	\$4.42	
	Finial Mount Adaptor	FSWT400	Finial Mount Adaptor for Wood Fascia	EA	\$4.42	
	Ripplefold Master Carriers	CD3412L 	6 wheels. Left.	EA	\$19.96	
		CD3412R 	6 wheels. Right.	EA	\$19.96	
	Ripplefold Butt Master Carriers	CD3600L 	Allows fold to butt together at the center of a center draw, creating no overlap.	EA	\$19.96	
		CD3600R 	3 snaps securely affix fabric to Butt Master.	EA	\$19.96	
	End Pulley for Ripplefold	CD4122L  CD4122R 	End Pulley with Ripplefold Pendant. Specify left or right.	EA	\$9.72	
	Ripplefold Friction Carrier, partial roll with 166 carriers	R1120/P	1 7/8" Spacing, 120% Fullness	ROLL	\$218.54	
		R1100/P	2 1/8" Spacing, 100% Fullness	ROLL	\$218.54	
		R1080/P	2 3/8" Spacing, 80% Fullness	ROLL	\$218.54	
		R1060/P	2 5/8" Spacing, 60% Fullness	ROLL	\$218.54	
	Ripplefold Roller Carrier, detachable pendant, partial roll with 166 carriers	R2120/P 	1 7/8" Spacing, 120% Fullness	ROLL	\$371.00	
		R2100/P 	2 1/8" Spacing, 100% Fullness	ROLL	\$371.00	
		R2080/P 	2 3/8" Spacing, 80% Fullness	ROLL	\$371.00	
		R2060/P 	2 5/8" Spacing, 60% Fullness	ROLL	\$371.00	
	Pinch Pleat Master Carriers	CD3300L 	6 wheels. Left.	EA	\$19.96	
		CD3300R 	6 wheels. Right.	EA	\$19.96	
	End Pulley for Pinch Pleat	CD4301L  CD4301R 	End Pulley with Carrier. Specify left or right.	EA	\$9.72	
	Micro Ball Bearing Carrier	CP10 	3 drapery pin holes, 5/8" width top	10/PK	\$10.42	
	Traverse Rod Cording	LC32/100	White - 100 yards	ROLL	\$67.13	
	Sure-Shade™ Universal Drive Tension Device	CT70/W	White *	*Complies with ANSI July 2024 Standard for Safety of Window Covering Products	EA	\$9.72
		CT70/DB	Dark Brown		EA	\$5.30

# 1 3/8" FINIAL STYLES

	Description	Item #	Finishes	UOM	Suggested Retail Price (SRP)
	Belmont Finial 4" L x 3" W	FSW138100W/	ES, MA, WA, PE, AW	EA	\$18.90
			UF	EA	\$17.66
	Hudson Finial 3 1/4" L x 3" W	FSW138101W/	ES, MA, WA, PE, AW	EA	\$25.08
			UF	EA	\$23.85
	Stratford Finial 3 1/4" L x 3" W	FSW138102W/	ES, MA, WA, PE, AW	EA	\$30.99
			UF	EA	\$29.75
	Princeton Finial 4" L x 2 3/4" W	FSW138103W/	ES, MA, WA, PE, AW	EA	\$32.08
			UF	EA	\$30.85
	Reid Finial 4 1/2" L x 2 1/2" W	FSW138104W/	ES, MA, WA, PE, AW	EA	\$31.41
			UF	EA	\$30.17
	Bellamy Finial (Resin) 3 3/4" L x 3" W	FSW138105R/	ES, MA, WA, PE, AW	EA	\$39.71
			UF	EA	\$38.48
	Morgan Finial (Resin) 3 3/4" L x 3" W	FSW138109R/	ES, MA, WA, PE, AW	EA	\$38.10
			UF	EA	\$36.87
	Provence Finial (Resin) 5 1/2" L x 2 3/4" W	FSW138106R/	ES, MA, WA, PE, AW	EA	\$42.05
			UF	EA	\$40.81
	Avery Finial (Resin) 4 1/2" L x 3" W	FSW138107R/	ES, MA, WA, PE, AW	EA	\$42.05
			UF	EA	\$40.81
	Hampton Finial (Resin) 4" L x 3 1/4" W	FSW138108R/	ES, MA, WA, PE, AW	EA	\$41.91
			UF	EA	\$40.67
	Knox End Cap 1 1/2" L x 2 1/4" W	FSW138190W/	ES, MA, WA, PE, AW	EA	\$14.65
			UF	EA	\$13.42

# 1 3/8" WOOD POLES

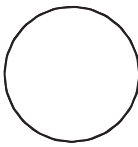
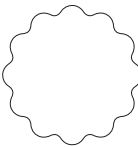
Can be custom cut for a \$5 cut fee FinestraCC. Please allow a 2 day lead time on all custom cut orders. All orders with a pole will incur a \$33.35 packaging fee per order.

	Description	Item #	Finishes	UOM	Suggested Retail Price (SRP)
	4' Smooth Pole	FSW138S04W/	ES, MA, WA, PE, AW	EA	\$55.95
			UF	EA	\$49.63
	6' Smooth Pole	FSW138S06W/	ES, MA, WA, PE, AW	EA	\$83.16
			UF	EA	\$74.36
	8' Smooth Pole	FSW138S08W/	ES, MA, WA, PE, AW	EA	\$111.77
UF			EA	\$100.50	
12' Smooth Pole	FSW138S12W/	ES, MA, WA, PE, AW	EA	\$154.75	
		UF	EA	\$141.56	
	4' Reeded Pole	FSW138F04W/	ES, MA, WA, PE, AW	EA	\$55.95
			UF	EA	\$49.63
	6' Reeded Pole	FSW138F06W/	ES, MA, WA, PE, AW	EA	\$83.16
			UF	EA	\$74.36
	8' Reeded Pole	FSW138F08W/	ES, MA, WA, PE, AW	EA	\$111.77
UF			EA	\$100.50	
12' Reeded Pole	FSW138F12W/	ES, MA, WA, PE, AW	EA	\$154.75	
		UF	EA	\$141.56	
	Wood Pole Splice	HH20	Zinc plated	10 per pack	\$10.76



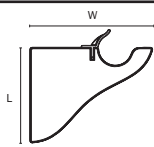
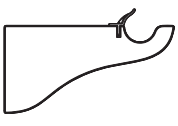
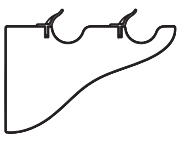
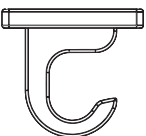
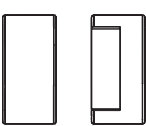
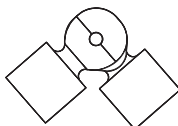

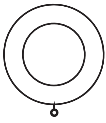

# 1 3/8" BRACKETS

	Description	Item #	Finishes	UOM	Suggested Retail Price (SRP)
	Single Bracket: 3 1/2" Return, 5" W x 3 7/8" L (clip 3/4" L), Base: 7/8" W x 3 7/8" L	FSW138400W/	ES, MA, WA, PE, AW	EA	\$27.56
			UF	EA	\$26.32
	Single Bracket: 6" Return, 7 1/2" W x 3 7/8" L (clip 3/4" L), Base: 7/8" W x 3 7/8" L	FSW138401W/	ES, MA, WA, PE, AW	EA	\$33.60
			UF	EA	\$32.36
	Double Bracket: 1 3/8" D Front, 1 3/8" D Back, 6" Front Return, 2 3/4" Back Return, 7 1/2" W x 4 5/8" L (clip 3/4" L), Base: 7/8" W x 4 5/8" L	FSW138402W/	ES, MA, WA, PE, AW	EA	\$37.24
			UF	EA	\$36.00
	Ceiling Bracket: 2 1/2" Drop, 1 3/4" W x 3 3/4" L, Base: 1 3/4" W x 4 1/8" L	FSW138403W/	ES, MA, WA, PE, AW	EA	\$38.52
			UF	EA	\$37.29
	Inside Mount Brackets: 1 7/8" Base, 7/8" Thick, 1/2" Inset	FSW138404W/	ES, MA, WA, PE, AW	PR	\$22.91
			UF	PR	\$21.68
	Swivel Socket: 5" Total L, 1 7/8" W, 1" Pole Inset	FSW138405W/	ES, MA, WA, PE, AW	EA	\$54.41
			UF	EA	\$53.25

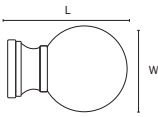
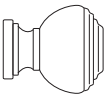

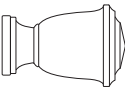
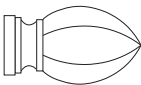
# 1 3/8" RINGS

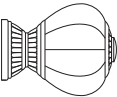
	Description	Item #	Finishes	UOM	Suggested Retail Price (SRP)
	Rings w/ Eyelet: 1 7/8" ID, 2 7/8" OD (Clips Included)	FSW138300W/	ES, MA, WA, PE, AW	8/pk	\$31.87
			UF	8/pk	\$30.64

# 2" FINIAL STYLES

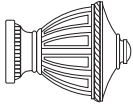

	Description	Item #	Finishes	UOM	Suggested Retail Price (SRP)
	Belmont Finial 5" L x 3 3/4" W	FSW200100W/	ES, MA, WA, PE, AW	EA	\$42.26
			UF	EA	\$39.78
	Hudson Finial 4 1/4" L x 3 3/4" W	FSW200101W/	ES, MA, WA, PE, AW	EA	\$46.11
			UF	EA	\$43.63
	Stratford Finial 4" L x 3 3/4" W	FSW200102W/	ES, MA, WA, PE, AW	EA	\$52.08
			UF	EA	\$49.61
	Princeton Finial 5" L x 3 3/4" W	FSW200103W/	ES, MA, WA, PE, AW	EA	\$54.06
			UF	EA	\$51.59
	Reid Finial 5 1/2" L x 3 1/4" W	FSW200104W/	ES, MA, WA, PE, AW	EA	\$49.42
			UF	EA	\$46.95
	Bellamy Finial (Resin) 4 3/4" L x 4" W	FSW200105R/	ES, MA, WA, PE, AW	EA	\$69.60
			UF	EA	\$67.13
	Morgan Finial (Resin) 4 3/4" L x 3 3/4" W	FSW200109R/	ES, MA, WA, PE, AW	EA	\$66.73
			UF	EA	\$64.26
	Provence Finial (Resin) 7" L x 3 1/2" W	FSW200106R/	ES, MA, WA, PE, AW	EA	\$75.44
			UF	EA	\$72.96

# 2" FINIAL STYLES

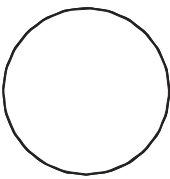
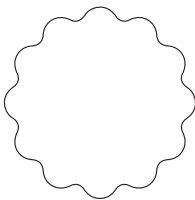

Description	Item #	Finishes	UOM	Suggested Retail Price (SRP)
 Avery Finial (Resin) 5 1/2" L x 3 1/2" W	FSW200107R/	ES, MA, WA, PE, AW	EA	\$75.44
		UF	EA	\$72.96
 Hampton Finial (Resin) 5" L x 4" W	FSW200108R/	ES, MA, WA, PE, AW	EA	\$75.09
		UF	EA	\$72.61
 Knox End Cap 1 3/4" L x 3" W	FSW200190W/	ES, MA, WA, PE, AW	EA	\$27.60
		UF	EA	\$25.13

# 2" WOOD POLES

Can be custom cut for a \$5 cut fee FinestraCC. Please allow a 2 day lead time on all custom cut orders. All orders with a pole will incur a \$33.35 packaging fee per order.

Description	Item #	Finishes	UOM	Suggested Retail Price (SRP)
 4' Smooth Pole	FSW200S04W/	ES, MA, WA, PE, AW	EA	\$116.99
		UF	EA	\$110.67
6' Smooth Pole	FSW200S06W/	ES, MA, WA, PE, AW	EA	\$173.88
		UF	EA	\$165.08
8' Smooth Pole	FSW200S08W/	ES, MA, WA, PE, AW	EA	\$233.99
		UF	EA	\$222.72
12' Smooth Pole	FSW200S12W/	ES, MA, WA, PE, AW	EA	\$328.44
		UF	EA	\$315.26
 4' Reeded Pole	FSW200F04W/	ES, MA, WA, PE, AW	EA	\$116.99
		UF	EA	\$110.67
6' Reeded Pole	FSW200F06W/	ES, MA, WA, PE, AW	EA	\$173.88
		UF	EA	\$165.08
8' Reeded Pole	FSW200F08W/	ES, MA, WA, PE, AW	EA	\$233.99
		UF	EA	\$222.72
12' Reeded Pole	FSW200F12W/	ES, MA, WA, PE, AW	EA	\$328.44
		UF	EA	\$315.26
 Wood Pole Splice	HH20	Zinc plated	10 per pack	\$10.76

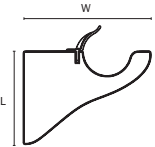
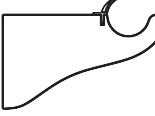

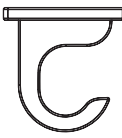
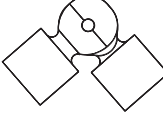
# 2" BRACKETS

	Description	Item #	Finishes	UOM	Suggested Retail Price (SRP)
	Single Bracket: 3 1/2" Return, 5 3/8" W x 3 7/8" L (clip 3/4" L), Base: 7/8" W x 3 3/8" L	FSW200400W/	ES, MA, WA, PE, AW	EA	\$37.38
			UF	EA	\$34.91
	Single Bracket: 6" Return, 7 7/8" W x 4 1/2" L (clip 3/4" L), Base: 7/8" W x 4 1/2" L	FSW200401W/	ES, MA, WA, PE, AW	EA	\$42.40
			UF	EA	\$39.92
	Double Bracket: 2" D Front, 1 3/8" D Back, 6 1/2" Front Return, 2 3/4" Back Return, 8 1/4" W x 4 5/8" L (clip 3/4" L), Base: 7/8" W x 4 5/8" L	FSW200402W/	ES, MA, WA, PE, AW	EA	\$48.23
			UF	EA	\$45.76
	Ceiling Bracket: 4" Drop, 1 3/4" W x 5 5/8" L, Base: 1 3/4" W x 5 1/2" L	FSW200403W/	ES, MA, WA, PE, AW	EA	\$48.93
			UF	EA	\$46.46
	Swivel Socket: 7" Total L, 2 3/8" W, 1 1/2" Pole Inset	FSW200405W/	ES, MA, WA, PE, AW	EA	\$63.61
			UF	EA	\$61.27

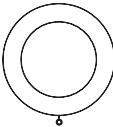
# 2" RINGS

	Description	Item #	Finishes	UOM	Suggested Retail Price (SRP)
	Rings w/ Eyelet: 2 5/8" ID, 3 7/8" OD (clips included)	FSW200300W/	ES, MA, WA, PE, AW	8/pk	\$73.27
			UF	8/pk	\$70.79

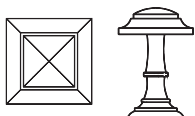
# HOLDBACKS

	Description	Item #	Finishes	UOM	Suggested Retail Price (SRP)
	Bretton Round Holdback	FSW900W/	ES, MA, WA, PE, AW	EA	\$45.76
			UF	EA	\$44.52
	Stratford Square Holdback	FSW901W/	ES, MA, WA, PE, AW	EA	\$45.76
			UF	EA	\$44.52
	Holdback Extension: 2" Projection	FSW990W/	ES, MA, WA, PE, AW	EA	\$9.08
			UF	EA	\$7.91





# FINESTRA® WOOD HARDWARE TRAVERSE AUTOMATED TRACK SYSTEM

Wall Mount  
Pinch Pleat & Ripplefold



SMART HOME COLLECTION  
by BUDGET BLINDS®

REV September 30, 2024

WOOD HARDWARE

ACCOUNT #

Company: \_\_\_\_\_ Contact: \_\_\_\_\_ Date: \_\_\_\_\_  
 Street address: \_\_\_\_\_ Person to contact with technical questions: \_\_\_\_\_  
 City: \_\_\_\_\_ State: \_\_\_\_\_ Zip: \_\_\_\_\_ PO: \_\_\_\_\_ Ph: \_\_\_\_\_ Fx: \_\_\_\_\_  
 E-mail: \_\_\_\_\_ (required for shipping confirmation)  
 Ship to: (if different from above) \_\_\_\_\_ Attn: \_\_\_\_\_  
 Street: \_\_\_\_\_ City: \_\_\_\_\_ State: \_\_\_\_\_ Zip: \_\_\_\_\_

PLEASE COMPLETE ITEMS 1 THROUGH 7. Email completed form to budgetblinds@rowleycompany.com

1 Total number of systems to be made to these specifications.  (Use another order form for systems with different specifications)

2 FRONT TRACK INFORMATION  
 Track / Bracket  WHITE  
 Color:  BRONZE  
 LENGTH  ft.  in.  
 Single Wall Mount  Double Wall Mount  
 3 1/2" - 4"  2 1/2" - 6 1/4"  2 1/2" - 6 1/4"  3 1/2" - 11"  
**NOTE - Components will match track color unless otherwise noted.**

3 MOTOR & COMPONENTS  
 Li-ion Battery (Includes Charger)  110v AC/DC Power Transformer  110v AC/DC Power Transformer 20'  
 Solar Panel  10' (Plug RTMP included)  3 Conductor Male Plug

4 DRAPERY STYLE  WHITE  BRONZE  
 PINCH PLEAT # \_\_\_\_\_  RIPPLEFOLD select fullness:  60%  100%  
 CP40 Carriers Roller Carriers  80%  120%

5 DRAW & MASTER CARRIER  
 ONE-WAY RIGHT (Motor right)  ONE-WAY LEFT (Motor left)  CENTER DRAW  OVERLAP MASTER  
 Motor right  Motor left  BUTT MASTER (Ripplefold Only)

6 FASCIA  
 STYLE:  Smooth  Reeded  
 SIZE:  1 3/8"  2" FINISH:  ES  MA  WA  PE  AW

7 IS THIS BUILD A DOUBLE TRACK?  Yes  No \*If yes, please complete items 8 through 13. If no, please skip to items 12 - 13.

8 BACK TRACK INFORMATION  
 Track / Bracket  WHITE  
 Color:  BRONZE  
 LENGTH  ft.  in.  
**NOTE - Components will match track color unless otherwise noted.**

9 MOTOR & COMPONENTS  
 Li-ion Battery (Includes Charger)  110v AC/DC Power Transformer  110v AC/DC Power Transformer 20'  
 Solar Panel  10' (Plug RTMP included)  3 Conductor Male Plug

10 DRAPERY STYLE  WHITE  BRONZE  
 PINCH PLEAT # \_\_\_\_\_  RIPPLEFOLD select fullness:  60%  100%  
 CP40 Carriers Roller Carriers  80%  120%

11 DRAW & MASTER CARRIER  
 ONE-WAY RIGHT (Motor right)  ONE-WAY LEFT (Motor left)  CENTER DRAW  OVERLAP MASTER  
 Motor right  Motor left  BUTT MASTER (Ripplefold Only)

\*Smart Home Controls below in item 12 sold separately.

12 SMART HOME CONTROLS\*  
 1 control required for track system to function. Smart Home Collection Push15 remote in white included, select alternative remote option for additional charge.  
 HANDHELD REMOTE | (15 Channel, 65' Range) |  SURFACE MOUNT WALL SWITCH (5 Channel, 65' Range)  
 HANDHELD REMOTE OPTIONS  
 1 Ch white |  Push15 black |  Push5 white |  Push5 black |  Level Control 15 Ch white  
 Optional add-on controls  
 WI-FI TO ARC BRIDGE HUB, 2-WAY RF (60' Range) |  ARC USB SIGNAL REPEATER (Extends the wireless range of the Smart Home Collection Hub and Remotes up to 60') |  INTERIOR SUN SENSOR (65' Range) |  WALL CHARGER

LARGER PROJECTION BRACKETS, RETURN PLATES / EXTENDERS AND DECORATIVE BATONS MAY BE PURCHASED SEPARATELY.

Length of Track	48"	96"	144"	192"
Brackets Included	3	4	5	6

SHIPPING » Flat Rate Shipping Program: Lengths over 8' will ship truck and incur an oversized fee. Splicing options for overlength sizes and alternative freight quotes available.

PACKAGING » All traverse orders will incur a \$33.35 packaging fee per order.

Rowley Company  
 230 Meek Road / Gastonia / NC / 28056  
 Phone: 877-323-0058  
 Fax: 800-554-0407  
 © 2024 Rowley Company, LLC

Signature of purchaser / cardholder \_\_\_\_\_ Date \_\_\_\_\_



# FINESTRA® WOOD HARDWARE TRAVERSE

## 4003N BATON DRAW TRACK SYSTEM

Wall Mount  
Pinch Pleat & Ripplefold



Style and service for every budget.™

REV November 4, 2024

WOOD HARDWARE

**ACCOUNT #**

Company: \_\_\_\_\_ Contact: \_\_\_\_\_ Date: \_\_\_\_\_  
 Street address: \_\_\_\_\_ Person to contact with technical questions: \_\_\_\_\_  
 City: \_\_\_\_\_ State: \_\_\_\_\_ Zip: \_\_\_\_\_ PO: \_\_\_\_\_ Ph: \_\_\_\_\_ Fx: \_\_\_\_\_  
 E-mail: \_\_\_\_\_ (required for shipping confirmation)  
 Ship to: (if different from above) \_\_\_\_\_ Attn: \_\_\_\_\_  
 Street: \_\_\_\_\_ City: \_\_\_\_\_ State: \_\_\_\_\_ Zip: \_\_\_\_\_

**PLEASE COMPLETE ITEMS 1 THROUGH 7.** Email completed form to [budgetblinds@rowleycompany.com](mailto:budgetblinds@rowleycompany.com)

**1** Total number of tracks to be made to these specifications →  (Use another order form for tracks with different specifications)

<b>2</b> FRONT TRACK INFORMATION Track / Bracket <input type="checkbox"/> WHITE Color: <input type="checkbox"/> BRONZE	LENGTH <input type="text"/> ft. <input type="text"/> in.	<input type="checkbox"/> SINGLE BRACKET 2 1/2" - 3 1/2" Projection	<input type="checkbox"/> DOUBLE BRACKET 2 1/4" - 3 1/2" Rear Projection, 5" - 6 1/4" Front Projection
------------------------------------------------------------------------------------------------------------------------------	----------------------------------------------------------	-----------------------------------------------------------------------	-------------------------------------------------------------------------------------------------------------

**3** DRAW  1-WAY LEFT  1-WAY RIGHT  CENTER DRAW  STATIONARY

<b>4</b> DRAPERY STYLE <b>NOTE</b> - Components will match track color unless specified.	<input type="checkbox"/> PINCH PLEAT CP10 Carriers	<input type="checkbox"/> RIPPLEFOLD Friction Carriers	circle fullness 60% 100%	*Baton sold separately.
	NUMBER OF PINCH PLEAT CARRIERS: _____	<input type="checkbox"/> RIPPLEFOLD Roller Carriers	80% 120%	

**5** MASTER CARRIER OVERLAP MASTER:  HIDDEN BATON  EXPOSED BATON  BUTT MASTER (Ripplefold Only)

**6** FASCIA STYLE:  Smooth  Reeded  
 SIZE:  1 3/8"  2" FINISH:  ES  MA  WA  PE  AW

**7** IS THIS BUILD A DOUBLE TRACK?  Yes  No

<b>8</b> BACK TRACK INFORMATION Track / Bracket <input type="checkbox"/> WHITE Color: <input type="checkbox"/> BRONZE	LENGTH <input type="text"/> ft. <input type="text"/> in.
-----------------------------------------------------------------------------------------------------------------------------	----------------------------------------------------------

**9** DRAW  1-WAY LEFT  1-WAY RIGHT  CENTER DRAW

<b>10</b> DRAPERY STYLE <b>NOTE</b> - Components will match track color unless specified.	<input type="checkbox"/> PINCH PLEAT CP10 Carriers	<input type="checkbox"/> RIPPLEFOLD Friction Carriers	circle fullness 60% 100%	*Baton sold separately.
	NUMBER OF PINCH PLEAT CARRIERS: _____	<input type="checkbox"/> RIPPLEFOLD Roller Carriers	80% 120%	

**11** MASTER CARRIER OVERLAP MASTER:  HIDDEN BATON  EXPOSED BATON  BUTT MASTER (Ripplefold Only)

**SPECIAL INSTRUCTIONS:**

LARGER PROJECTION BRACKETS, RETURN PLATES / EXTENDERS AND DECORATIVE BATONS MAY BE PURCHASED SEPARATELY.

Length of Track	48"	96"	144"	192"
Brackets Included	3	4	5	6

**SHIPPING** » Flat Rate Shipping Program: Lengths over 8' will ship truck and incur an oversized fee. Splicing options for overlength sizes and alternative freight quotes available.

**PACKAGING** » All traverse orders will incur a \$33.35 packaging fee per order.

**Rowley Company**  
 230 Meek Road / Gastonia / NC / 28056  
 Phone: 877-323-0058  
 Fax: 800-554-0407  
 © 2024 Rowley Company, LLC

\_\_\_\_\_  
 Signature of purchaser / cardholder

\_\_\_\_\_  
 Date



# FINESTRA® WOOD HARDWARE TRAVERSE 4001 CORD DRAW TRACK SYSTEM

Wall Mount  
Pinch Pleat & Ripplefold



Style and service for every budget.™

REV November 4, 2024

WOOD HARDWARE

ACCOUNT #

Company: \_\_\_\_\_ Contact: \_\_\_\_\_ Date: \_\_\_\_\_  
 Street address: \_\_\_\_\_ Person to contact with technical questions: \_\_\_\_\_  
 City: \_\_\_\_\_ State: \_\_\_\_\_ Zip: \_\_\_\_\_ PO: \_\_\_\_\_ Ph: \_\_\_\_\_ Fx: \_\_\_\_\_  
 E-mail: \_\_\_\_\_ (required for shipping confirmation)  
 Ship to: (if different from above) \_\_\_\_\_ Attn: \_\_\_\_\_  
 Street: \_\_\_\_\_ City: \_\_\_\_\_ State: \_\_\_\_\_ Zip: \_\_\_\_\_

**PLEASE COMPLETE ITEMS 1 THROUGH 7.** Email completed form to [budgetblinds@rowleycompany.com](mailto:budgetblinds@rowleycompany.com)

**1** Total number of tracks to be made to these specifications.  (Use another order form for tracks with different specifications)

**2 FRONT TRACK INFORMATION**  
 Track / Bracket  WHITE  
 Color:  BRONZE  
 LENGTH  ft.  in.  
 SINGLE BRACKET 3 1/4" Projection  
 DOUBLE BRACKET 2 1/4" - 4 1/2" Rear Projection, 5 1/2" - 7" Front Projection

**3 DRAW**  
 1-WAY LEFT  1-WAY RIGHT  CENTER DRAW  Right Cord  STATIONARY  
 Left Cord

**4 DRAPERY STYLE**  
**NOTE** - Components will match track color unless specified.  
 PINCH PLEAT # \_\_\_\_\_ CP10 Carriers  
 RIPPLEFOLD Friction Carriers circle fullness 60% 100%  
 RIPPLEFOLD Roller Carriers 80% 120%  
 BUTT MASTER (Ripplefold only)

**5 CORD COLOR:** WHITE CORD DROP LENGTH: \_\_\_\_\_"

**6 FASCIA**  
 STYLE:  Smooth  Reeded  
 SIZE:  1 3/8"  2"  
 FINISH:  ES  MA  WA  PE  AW

**7** IS THIS BUILD A DOUBLE TRACK?  Yes  No

**8 BACK TRACK INFORMATION**  
 Track / Bracket  WHITE  
 Color:  BRONZE  
 LENGTH  ft.  in.

**9 DRAW**  
 1-WAY LEFT  1-WAY RIGHT  CENTER DRAW  Right Cord  
 Left Cord

**10 DRAPERY STYLE**  
**NOTE** - Components will match track color unless specified.  
 PINCH PLEAT # \_\_\_\_\_ CP10 Carriers  
 RIPPLEFOLD Friction Carriers circle fullness 60% 100%  
 RIPPLEFOLD Roller Carriers 80% 120%  
 BUTT MASTER (Ripplefold only)

**11 CORD COLOR:** WHITE CORD DROP LENGTH: \_\_\_\_\_"

**SPECIAL INSTRUCTIONS:**

LARGER PROJECTION BRACKETS & RETURN PLATES / EXTENDERS MAY BE PURCHASED SEPARATELY.

Length of Track	48"	96"	144"	192"
Brackets Included	3	4	5	6

SHIPPING » Flat Rate Shipping Program: Lengths over 8' will ship truck and incur an oversized fee.  
Splicing options for overlength sizes and alternative freight quotes available.

PACKAGING » All traverse orders will incur a \$33.35 packaging fee per order.



**Rowley Company**  
230 Meek Road / Gastonia / NC / 28056  
Phone: 877-323-0058  
Fax: 800-554-0407  
© 2024 Rowley Company, LLC

Signature of purchaser / cardholder

Date



WOOD HARDWARE

## TO PLACE AN ORDER

Phone | 877.323.0058  
E-Mail | budgetblinds@rowleycompany.com

230 Meek Road  
Gastonia, NC 28056

Offices are open Monday - Friday  
8:00AM - 6:00PM ET

**FINESTRAWOODHARDWARE.COM**

Finestra® is a registered trademark of Rowley® Company, LLC. All products and designs are © 2024, Rowley® Company, LLC.

### PRODUCT INFORMATION

The Finestra® Wood Hardware program consists of 1 3/8" and 2" poles, finials, brackets and accessories all available in 5 furniture-quality finishes and an unfinished option. The finials are made of wood and resin as noted by the W and R in the item numbers while the poles, brackets and accessories are made of wood. Pair the beauty of Finestra Wood finials with the superior functionality of our Finestra Wood Traverse Systems. Available in 2" and 1 3/8" diameter coordinating wood fascia and a wide array of traversing solutions, including Automated Track, single or double rod, baton draw or cord draw, pinch pleat or Ripplefold. All items are intended for indoor use only.

### PRICING

Prices are effective September 30, 2024 and subject to change without notice. Due to the U.S. government's current policy on China tariffs, all products are subject to a tariff surcharge as of September 1<sup>st</sup>, 2019. Effective January 1, 2023, a \$6 transaction/handling fee is added to all Rowley products.

### NEW TRADE ACCOUNTS

Qualifications:

1. Customer must have a related business.
2. The following must be presented as proof of business:
  - Business License
  - Sales tax I.D. certificate
3. All merchandise must be for resale.

### PAYMENT TERMS & CONDITIONS

VISA, MasterCard, AMEX and Discover Card are accepted. Online orders paid by credit card are processed and charged at the time the order is submitted online. Credit applications must be filled out in order to establish an open credit account payable by company checks. Approved credit terms are net 30 days from date of shipment. A 1.5% per month service charge will be applied to past due balances. Accounts inactive for a 12-month period will automatically be closed and subject to the above conditions before re-establishing the account.

### CANCELLATION POLICY

In order to maintain high-quality service levels, we process all orders as they are received. Orders cannot be cancelled.

### SHIPPING & DELIVERY

Finestra® Wood Hardware orders placed before 3 PM EST are

shipped the same day when shipped via FedEx. Please allow a 5 day lead time on all manual traverse orders and a 10 - 15 day lead time on automated traverse orders. Please allow a 2 day lead time on all custom cut orders. Shipping charges will be calculated at checkout. Flat Rate Shipping Program Lengths over 8' will ship truck and incur an oversized fee. Splicing options for overlength sizes and alternative freight quotes available. Call 800.343.4542 to get the best shipping rate to your location. Residential fees may apply. Customer is responsible for freight charges on refused or undeliverable orders.

### PACKAGING FEES

A packaging fee of \$33.35 per order will apply to any order that has a pole or traverse rod up to 16'. This fee covers the additional labor and materials needed to securely package these products, ensuring they arrive intact and damage-free.

### FREIGHT DAMAGES / CLAIMS

Claims for shortages, damages and discrepancies must be made within 10 days of receipt of goods and must have original shipping carton. Truck freight damage must be written on the Bill of Lading at the time of delivery for damage claims to be made. No exceptions.

### MERCHANDISE RETURNS

- Returns must have and reference a Return Authorization number (RMA#), be returned in original package and be resalable as new.
- All returns made after 30 days from date of purchase, except for defective products, will be charged a minimum 20% restocking fee.
- No returns will be accepted after 60 days from date of purchase.
- Any product returned without an RMA# will not be issued a credit.
- Credit will be issued on merchandise only, not freight.
- Return shipping is the customer's responsibility and should be sent prepaid. COD's are not accepted.
- No returns on clearance or discontinued items or on items with custom or shimmer finishes.

### WARRANTY

5 year warranty on Slim Drapery Motor.