

MANUAL TRAVERSING CLUTCH SOFT SHADE SYSTEMS

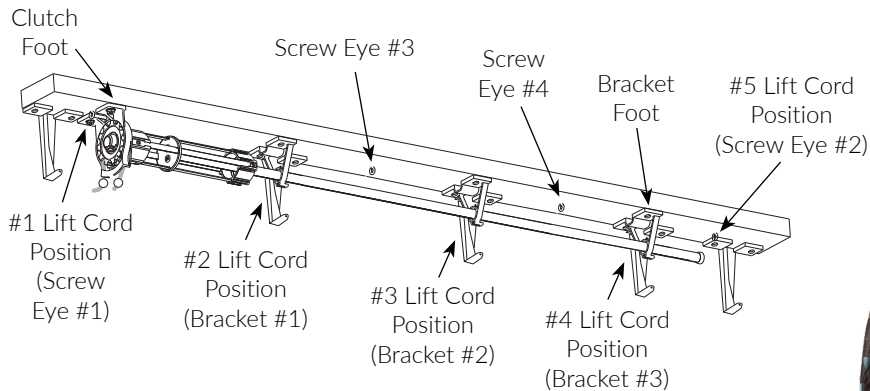

1 – CHOOSE YOUR SHADE QUANTITY

Let our in-house experts know how many shades to assemble.

2 – CHOOSE YOUR SHADE WEIGHT & CLUTCH UNIT SIZE

Your shade weight determines clutch unit size. Select under 15 lbs. or 15 to 30 lbs.

3 – CHOOSE YOUR SHADE DIMENSIONS

Maximum Width is 168". Maximum Length is 144". The minimum dustboard depth when using Clutch Unit RW30 is 2 ½". However, for Clutch Unit RW15, the 1 ½" dustboard depth can be used. For a shade that requires the smaller dustboard, also use our EZ Rig Shade System.

4 – CHOOSE YOUR CONTROL POSITION

Select either Left or Right side of shade.

5 – CHOOSE YOUR COLOR

Pick the color of your Plastic Bead Chain & Tension Device. Available in White, Off-White or Specify Other.

6 – CHOOSE YOUR LENGTH OF BEAD CHAIN LOOP

Standard drop lengths are 2', 3', 4', 5', 6'.

7 – CHOOSE YOUR LIFT CORD SPECIFICATIONS

Select the Number of Columns of Lift Cord on the shade. Indicate the distances between each column. Minimum spacing = 7".

**Builds do not include Lift Cord. Remember to order Lift Cord.*

8 – CHOOSE YOUR SHADE MOUNT

Select Front / Standard or Reverse.



MANUAL TRAVERSING CLUTCH SOFT SHADE SYSTEM

REV February 1, 2025

Encased Lift Cord | BUILDS DO NOT INCLUDE LIFT CORD
12" cords are only included to show the correct routing

ACCOUNT # _____

Company _____ Contact _____ Date _____
 Street Address _____ Person to contact with technical questions _____
 City _____ State _____ Zip _____ PO _____ Phone _____
 Email _____ (required for shipping confirmation)
 Ship to (if different from above) _____ Attn _____
 Street Address _____ City _____ State _____ Zip _____

PLEASE COMPLETE ITEMS 1 THROUGH 9.

For assistance, call Customer Service at 800.343.4542 or 704.866.0650.
Email completed form to sales@rowleycompany.com.

1 Total number of shades to be made to these specifications → (Use another order form for shades with different specifications)

2 SHADE WEIGHT: Include the weight of the fabric, lining, stiffeners & bottom weights. UNDER 15 LBS. Clutch Unit | RW15 15 TO 30 LBS. Clutch Unit | RW30

3 EXACT SHADE DIMENSIONS in inches. We do not make any additional deductions. **We do not accept Traversing Clutch Shade orders wider than 168" or taller than 144".**
 DEPTH OF DUSTBOARDS: The minimum dustboard depth when using Clutch Unit RW30 is 2 1/2". However, for Clutch Unit RW15, the 1 1/2" dustboard depth can be used. For a shade that requires the smaller dustboard, also use our EZ Rig Shade System.

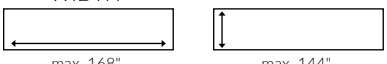
WIDTH LENGTH

 max. 168" max. 144"
 RW15 Clutch - Dustboard Size 3/4" x 1 1/2"
 RW30 Clutch - Dustboard Size 3/4" x 2 1/2"

4 CONTROL POSITION LEFT SIDE RIGHT SIDE

5 PLASTIC BEAD CHAIN / TENSION DEVICE COLOR: Plastic Bead Chain is rated: 30 lbs. WHITE OFF-WHITE OTHER _____

6 LENGTH OF BEAD CHAIN LOOP: Standard drop lengths are 2', 3', 4', 5', 6'.
 SEE STANDARD SIZES AT LEFT FEET

7 NUMBER OF COLUMNS OF ENCASED LIFT CORD ON THE SHADE. COLUMNS
 INDICATE THE DISTANCES BETWEEN EACH COLUMN OF ENCASED LIFT CORD ON THE SHADE.
 Minimum spacing = 7". Your headrail will be built according to the measurements you provide on the chart below. Your sketch doesn't have to be to scale, but THE NUMBERS MUST BE ACCURATE to the nearest 1/8". Draw vertical lines to show the columns of Encased Lift Cord. Be sure to include every column, including those close to the edges of the headrail. The first two columns are sketched for you. Write the measurements to indicate the distance between each column of Encased Lift Cord and the next. CHECK THAT THESE MEASUREMENTS ADD UP TO THE EXACT SHADE WIDTH IN ITEM 4.

← →	← →	← →	← →
← 1/2" →	Minimum 1/2" from the end on each side.	EXAMPLE	← 1/2" →
		<input type="text" value="1/2"/> <input type="text" value="10"/> <input type="text" value="10"/> <input type="text" value="1/2"/> = (21" Headrail)	

8 SHADE MOUNTING: Shades are typically mounted over the front of the operating system. Indicate if you plan to mount to the back of the operating system by checking the box. No additional charge. FRONT MOUNT STANDARD REVERSE MOUNT

9 READ THE TERMS OF SALE on the Custom Solutions Payment Form on page 3, sign and submit along with your signed forms.

*Builds do not include Lift Cord. Remember to order Lift Cord.

SHIPPING » [Flat Rate Shipping Program](#) Lengths over 8' will ship truck and incur an oversized  fee.

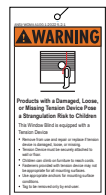
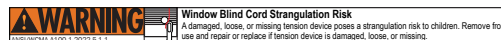

 Rowley® Company
230 Meek Road / Gastonia / NC / 28056
Phone » toll-free 800-343-4542 or local 704-866-0650
© 2025 Rowley® Company, LLC





Signature of purchaser / cardholder Date

PAYMENT FORM

ACCOUNT # _____

To place a Custom Solutions Shade System or Drapery Hardware System order, you must complete and sign the Payment Form along with the applicable system build form. You may submit your completed forms via email to Sales@RowleyCompany.com.

For Order Forms, visit RowleyCompany.com/CustomSolutions

<input type="radio"/> OVERNIGHT SHIPPING (additional freight will apply)	SHIPPING » Flat Rate Shipping Program Lengths over 8' will ship truck and incur an oversized fee. Splicing options for overlength sizes and alternative freight quotes available.
SELECT ONE <input type="radio"/>  <input type="radio"/>  <input type="radio"/>  <input type="radio"/> 	EXPIRATION DATE [][][][][]
CREDIT CARD # - LAST 4 DIGITS [][][][]	SECURITY CODE [][][][]
I authorize Rowley® Company to charge the credit card above for all of my orders submitted to Rowley® Company. I have read, understood and agree to the Terms of Sale on this payment form.	
<div style="border: 1px solid black; padding: 5px; margin-bottom: 5px;"> Credit Card Billing Address (if different than ship to address) </div> _____ Complete Name of Card Holder _____ Street Address _____ City State Zip _____ Phone _____ Email _____	<div style="border: 1px solid black; padding: 5px; margin-bottom: 5px;"> <input type="checkbox"/> Ship and apply to my pre-approved Net 30 account. Account # _____ </div> The price of the custom build includes all parts, labor and packaging, but does not include sales tax where applicable or shipping charges, for which the receiver is responsible. All orders will ship within five business days from confirmation of order with satisfactory payment arrangements. Automated® Traverse orders will ship within 10 - 15 business days. For commercial orders, request a quote with timeline. Terms: Net 30 days to pre-approved accounts only or credit card. Prices, design and availability are subject to change or withdrawal without notice.
_____ Signature of purchaser / cardholder	_____ Date

TERMS OF SALE WARRANTIES BY ROWLEY® COMPANY

Rowley® Company agrees to repair or replace, free of charge, any Custom Solutions Shade or Track System that due to faulty parts or workmanship in the assembled Shade or Track System is returned freight pre-paid to Rowley® Company within ninety (90) days of delivery. The parts in the system are covered by a ten year warranty. These warranties do not cover systems that have been subjected to abuse. The Slim Drapery Motor is covered by a 5 year warranty.

Orders for Custom Solutions Shade or Track Systems are not cancelable and cannot be altered. Custom Solutions Shade or Track Systems are not returnable for any reason except warranty repair, as described above. The buyer verifies that all sizes and other specifications are correct. A Custom Solutions Shade or Track System will be custom-built to the size and other specifications written on the system order form. Rowley® Company will repair or replace without charge any Custom Solutions Shade or Track System that is not made correctly to those specifications. THE CUSTOMER WILL BE CHARGED FOR ANY REPAIRS OR REPLACEMENT NECESSITATED BY AN ERROR IN THE MEASUREMENT OR OTHER SPECIFICATIONS.

OWNERSHIP: All selected shipping preferences are F.O.B. shipping point from any Rowley® location; the buyer owns the shipment as soon as it leaves the Rowley® Company loading dock. In the event of damaged shipment, the buyer must accept the shipment and place a claim with the carrier. Prices quoted include all parts, labor and packaging for all Custom Solutions Shade or Track Systems. The buyer is responsible for shipping costs.